

ד"ח כסלו

ד"ח כסלו













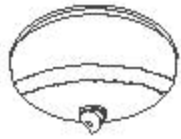
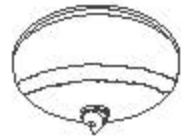







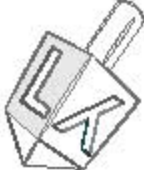

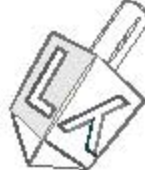

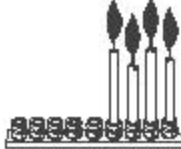

הוראה גזר עיגול אחד לכרטיסים. שחקו לוטו.

מגוון לוחות בגיל הרך
קוביות
להתפתחות המקצועית שלך



הוראה: מצאו את הציור שזהה בכיוונו לציור שמשמאל.

מגוון לוחיות בגיל הודן
קוביות
להתפתחות המקצועית שלך

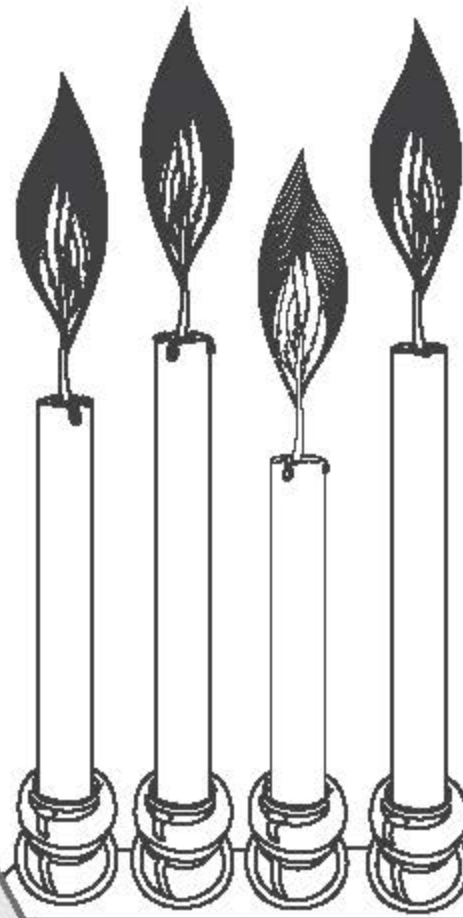

צבעו את הנר הנמוך ביותר בצבע אדום.

צבעו את הסופגניה שעומדת ליד הסביבון בחום.

צבעו את המטבעות שלפני החנוכיה בצהוב.

צבעו את שני הנרות שבאותו גובה בצבע כחול.

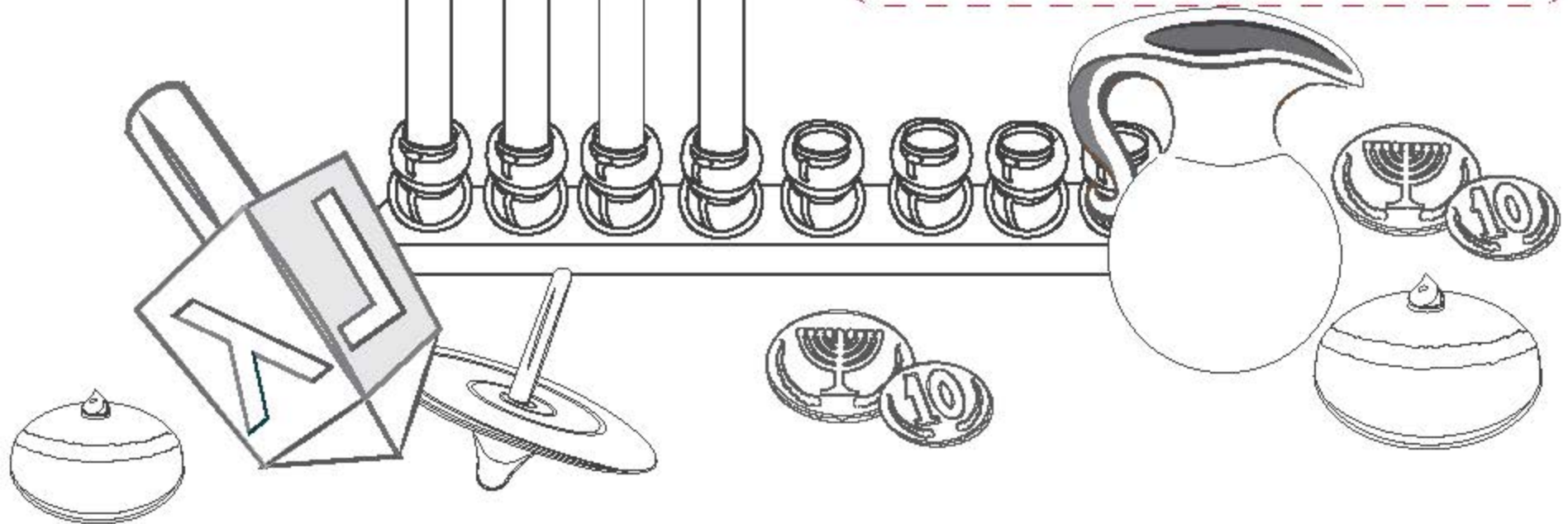

הוראה: הדביקו מדבקות גדולות על הכד הגדול, וקטנות על הקטן.

מגוון לוחיות בגיל הודן
קוביות
להתפתחות המקצועית שלך



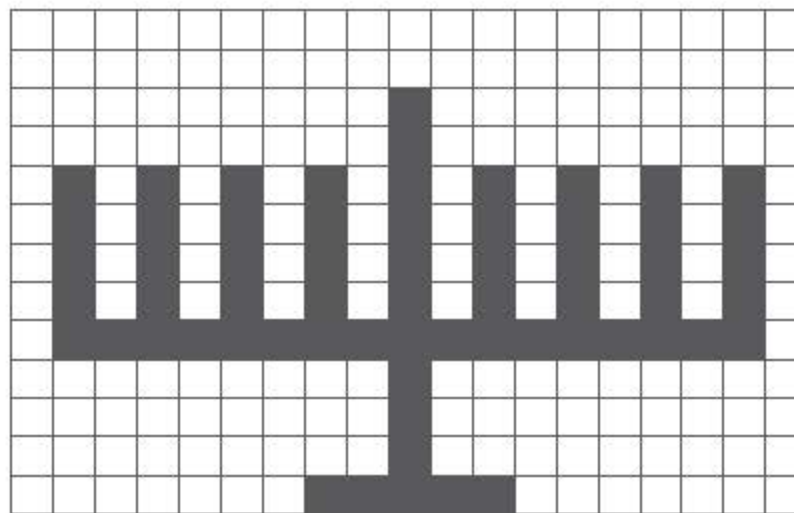
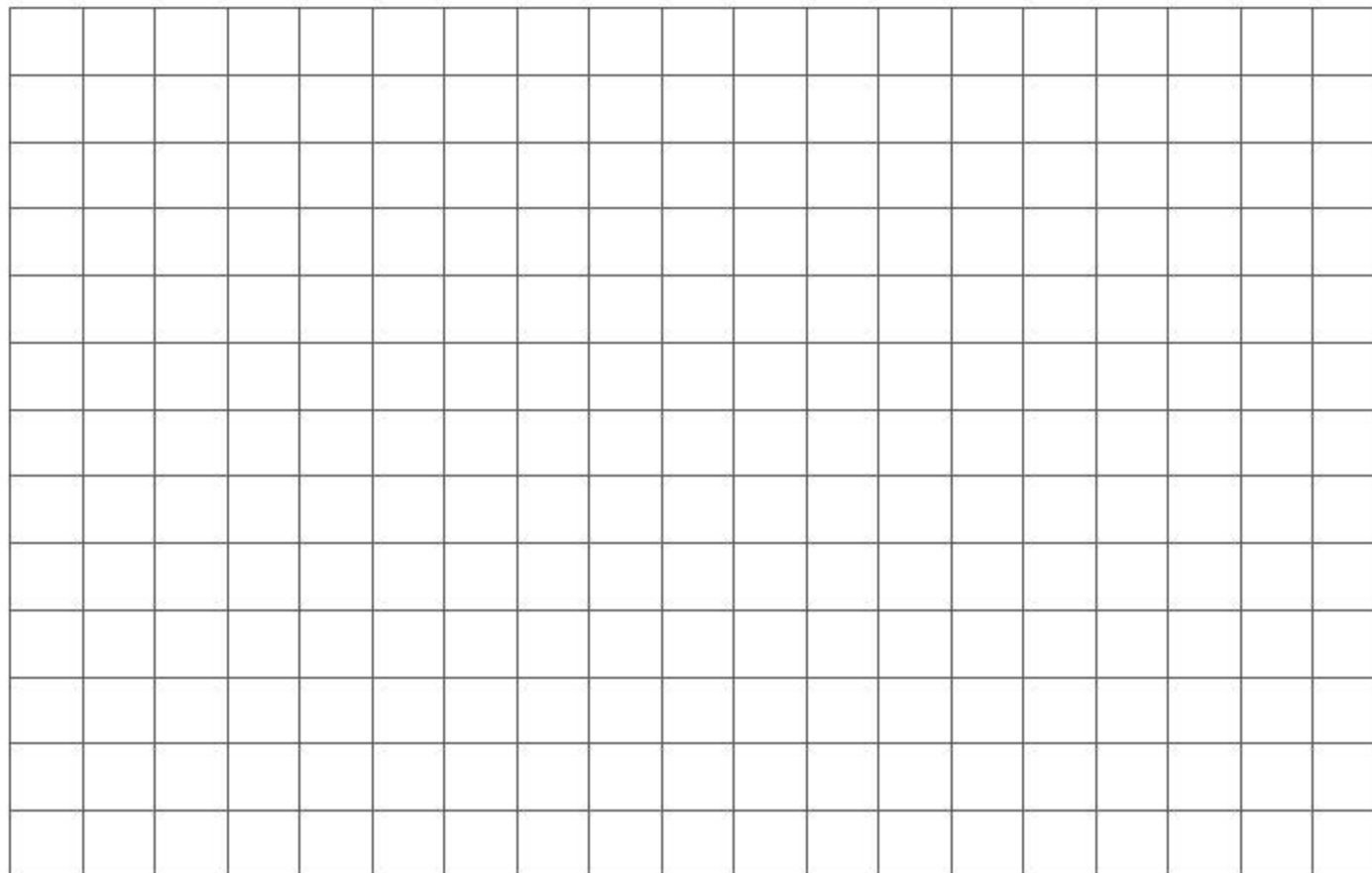

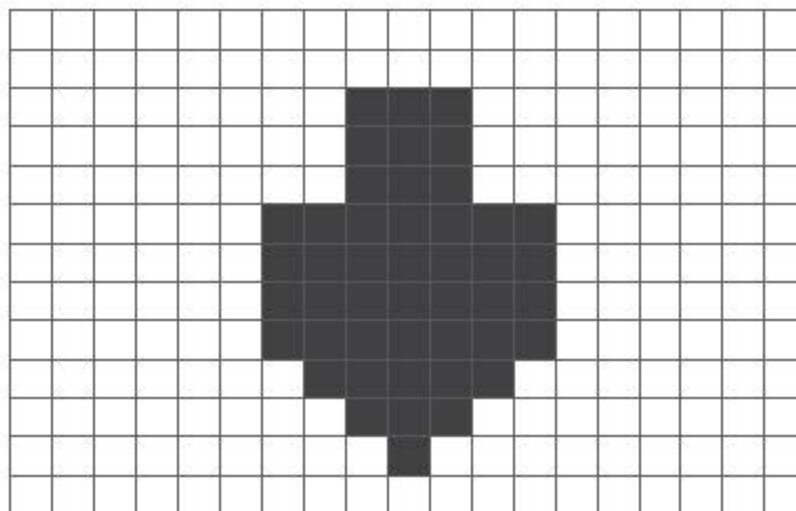
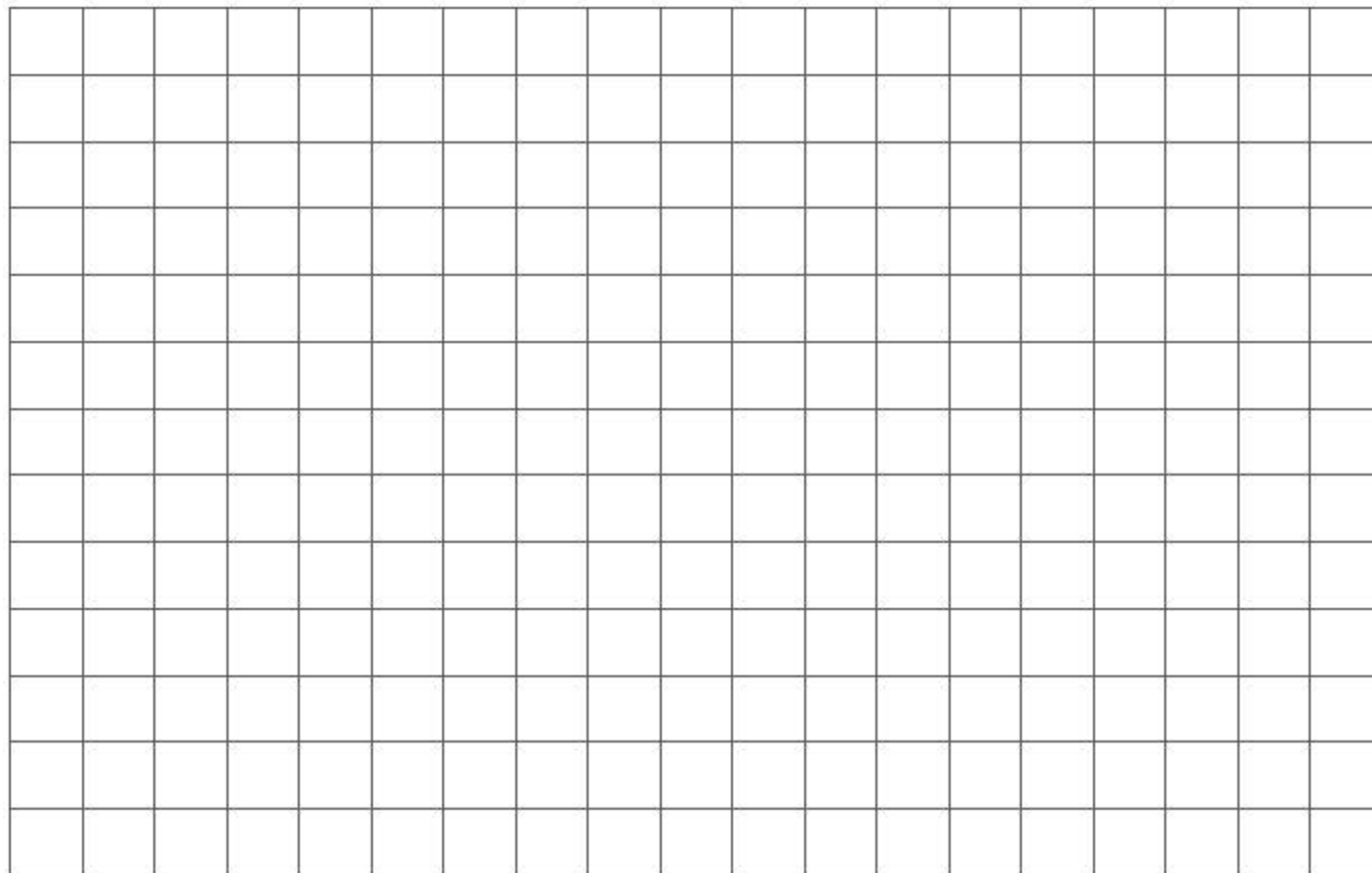

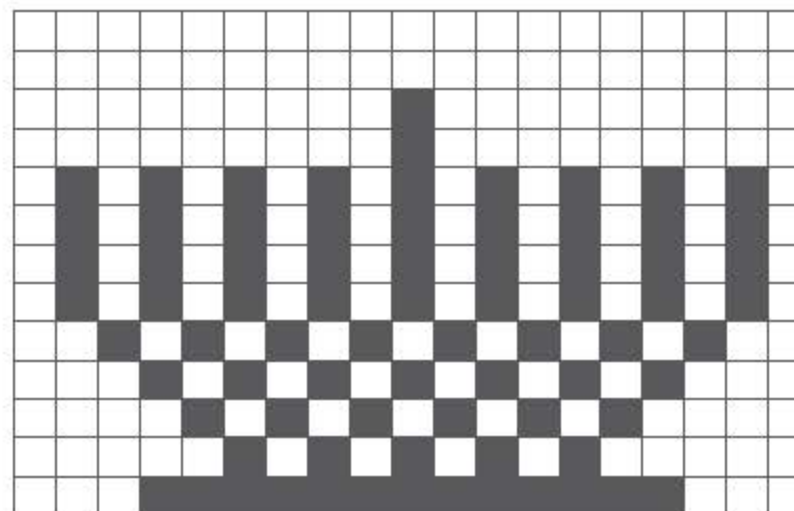
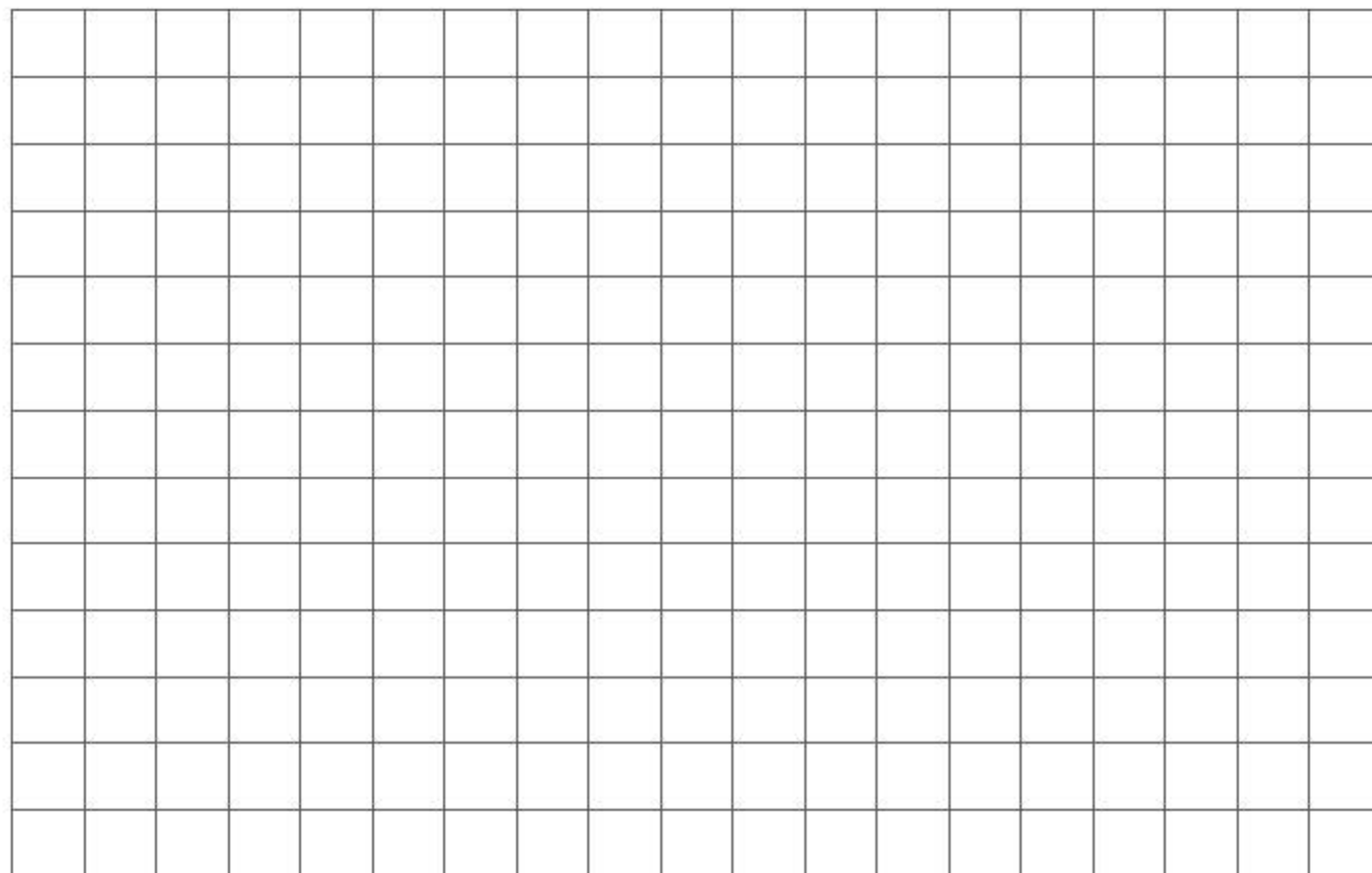

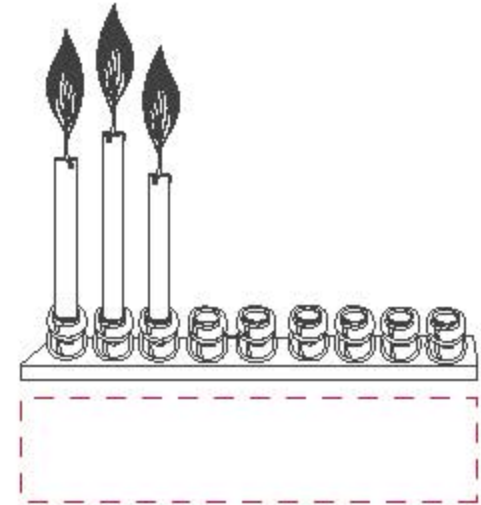
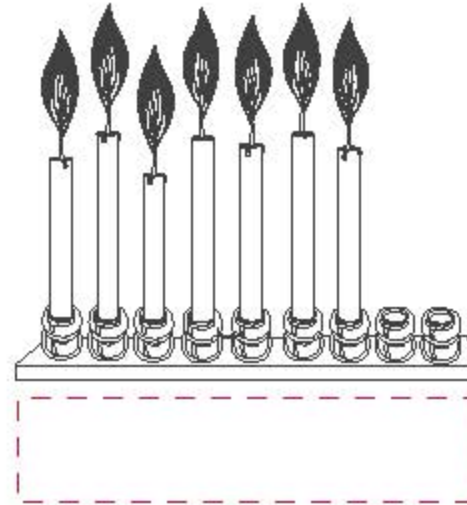
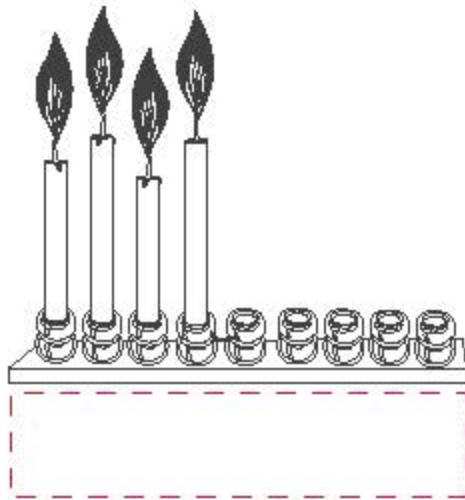
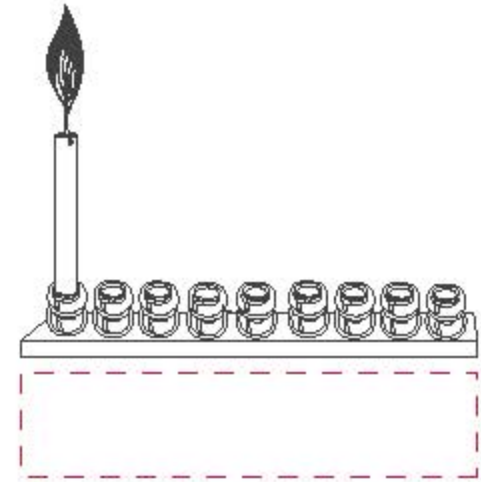
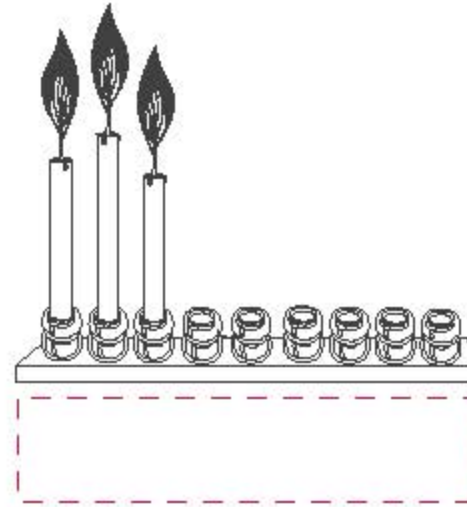
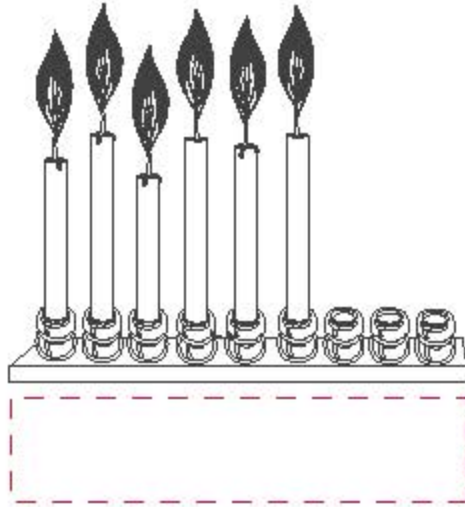

הוראה: מתחו קו אל הצליל הפותח מימין, ואל הצליל הסוגר משמאל.

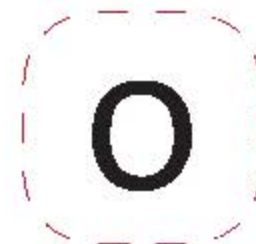
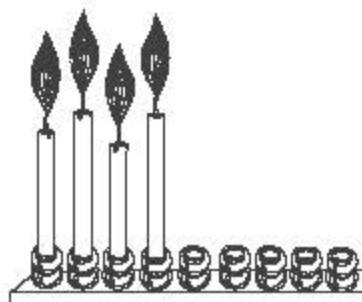
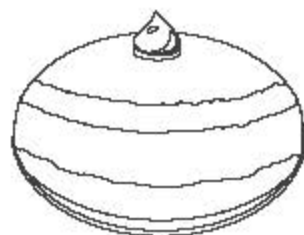

מבין לחיות בגיל הרך
קוביות
להתפתחות המקצועית שלך



מבין לחיטור בגיל הרך
קוביות
להתפתחות המקצועית שלך



מכון לחינוך בגיל הרך
קוביות
להתפתחות המקצועית שלך



מבין לתינוך בגיל הרך
קוביות
להתפתחות המקצועית שלך



- צבעו את הכד שעל השלחן בירוק.
- צבעו את הכד שמתחת לשלחן בחום.
- צבעו את הסביבון שעל השלחן באדום.
- צבעו את הסביבון שמתחת לשלחן בצהוב.
- צבעו את הסופגניה של השלחן בחום.
- צבעו את הסופגניה שמתחת לשלחן בצהוב.

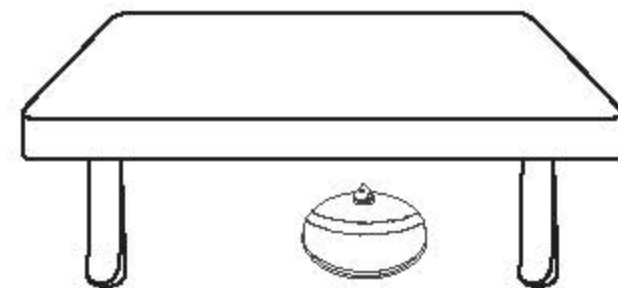
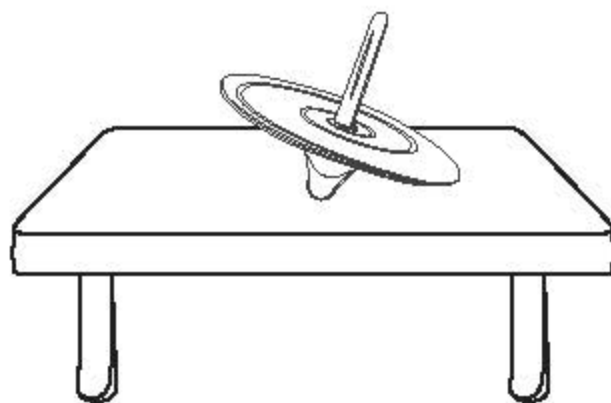
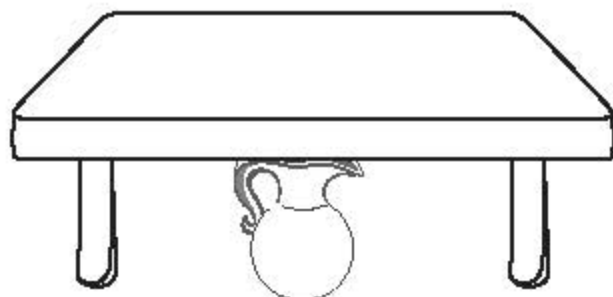
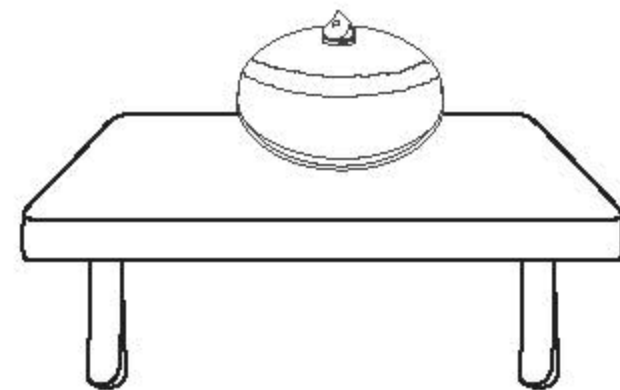
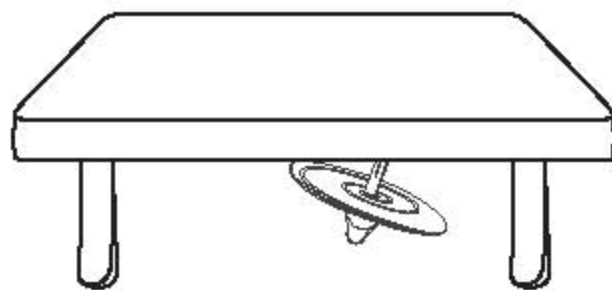
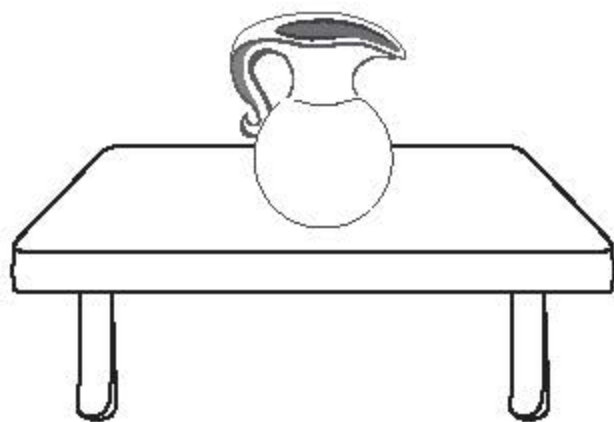

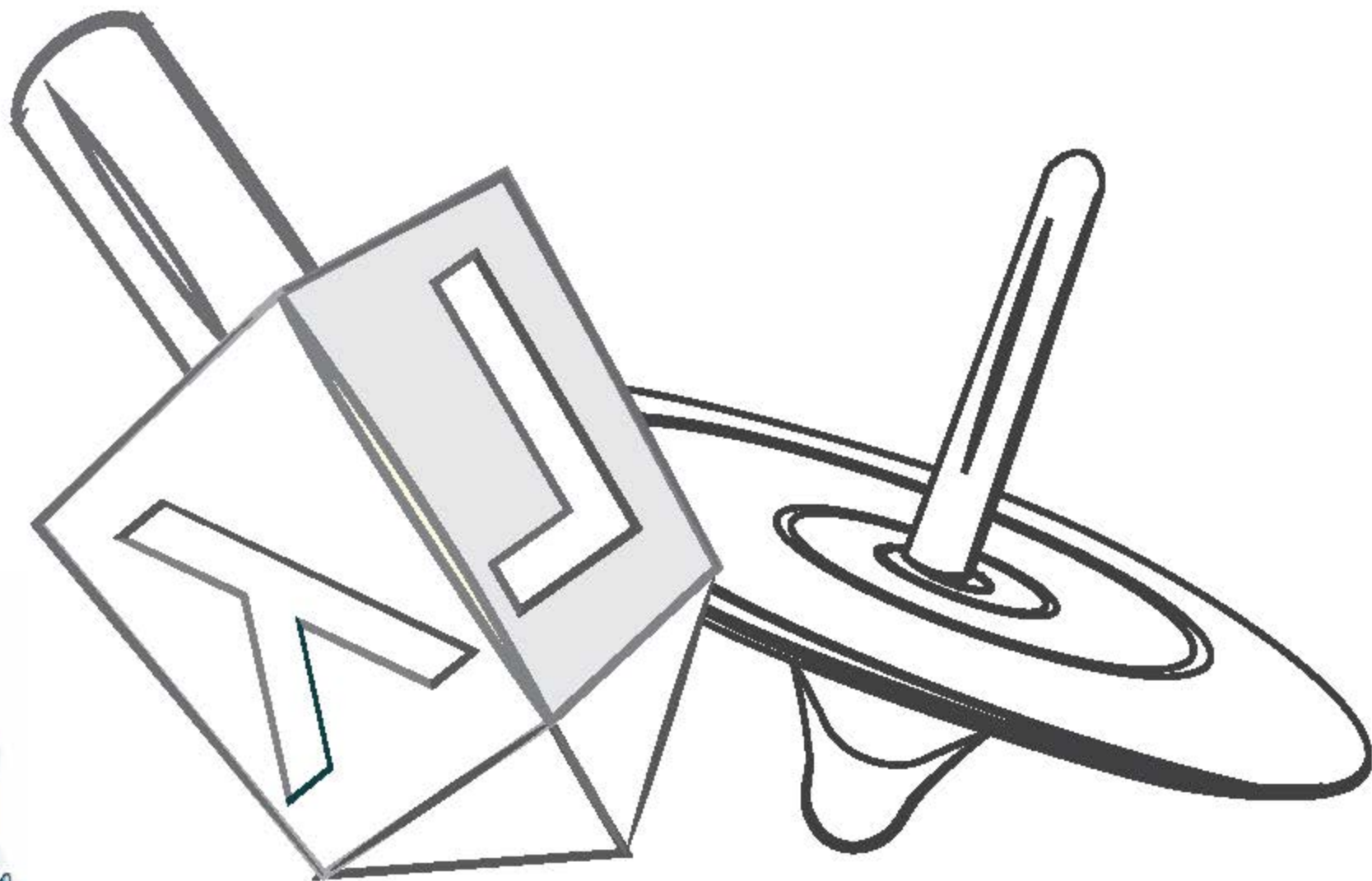

הוראה: עברו על המסלול שעשה הסביבון.

מבין לחינוך בגיל הרך
קוביות
להחפתחות המקצועית שלך

